

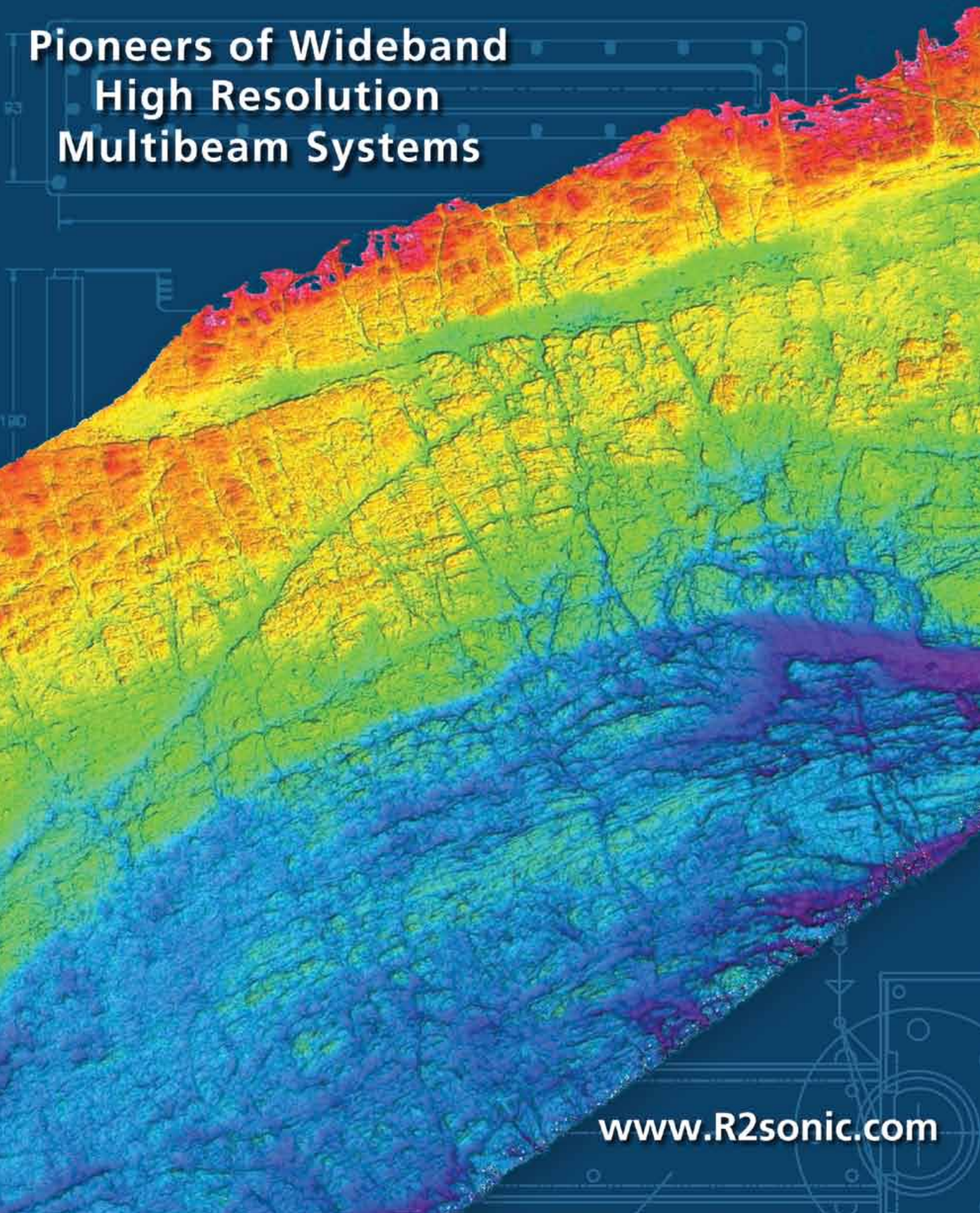

# R2SONIC

**Pioneers of Wideband  
High Resolution  
Multibeam Systems**



[www.R2sonic.com](http://www.R2sonic.com)





## Company Profile

---



R2Sonic was founded in February 2006 by three veteran underwater acoustical engineers; Jens R. Steenstrup, Mark Chun and Kirk Hobart; with the mission to utilize their experience to bring high quality, leading edge underwater acoustic products to the private and public sectors, with focus on customer needs.



R2Sonic founders and personnel bring over 25 years of market driven quality engineering design and manufacturing experience, utilizing “best practice” design and manufacturing process.

R2Sonic brings pioneering values to the industry. With the launch of the innovative Sonic 2024 and 2022 Broadband / Wideband Multibeam Systems, R2Sonic has redefined the Multibeam market with unparalleled performance with unique system features and application growth capabilities.



## Facilities

---

The new R2Sonic Headquarters are conveniently located 10 minutes from Austin city center, 10 minutes from Lake Travis and 15 minutes from the International airport, in the high technology corridor. The facilities are well equipped with modern instrumentation and software tools necessary for the efficient modeling, development and test of underwater acoustical equipment.

## Systems Overview

The Sonic Broadband / Wideband Multibeam Echo Sounders represent the latest in advanced underwater acoustic technology.

The Sonic Broadband / Wideband Multibeam Echo Sounders are the world's first true wideband high resolution shallow water multibeam echo sounders. With proven results and unmatched performance, the Sonic systems produce reliable and remarkably clean data with maximum user flexibility through all range settings.

The unprecedented 60 kHz signal bandwidth offers twice the resolution of any other commercial sonar in both data accuracy and imagery.

With over 20x selectable operating frequencies to choose from within the 200 to 400kHz band, the user is not limited by two or three operating frequencies and thus can trade off resolution and range and effectively control interference from other active acoustic systems.

In addition to selectable operating frequencies, Sonic systems provide variable swath coverage selections from 10° to 160° on the fly, in real-time and across all frequencies from 200 to 400 kHz. The operator may also rotate the sector to precise location either port or starboard side of the vessel. No other high resolution, high frequency sonar offers such variability of coverage and productivity.

When a narrow sector is selected, all soundings are concentrated within the swath for increased resolution over small scale bottom features. Wide swath sectors are typically used for general mapping or when surveying vertical surfaces such as quays, breakwaters, dams, pilings or bridge abutments as the increased opening angles eliminate need to rotate the sonar head.

Equidistant beam spacing, roll stabilization and unique automated range, gate and slope tracking functions are incorporated for Sonic systems, increasing system overall efficiency. Advanced optional functions including Ultra-High Resolution 700kHz providing unprecedented narrow 0.3° x 0.6° beam widths (2024), TruePix™ Backscatter output, Raw Water Column and Switchable Forward Looking Sonar output are also provided.

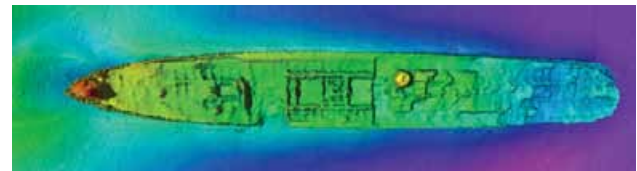
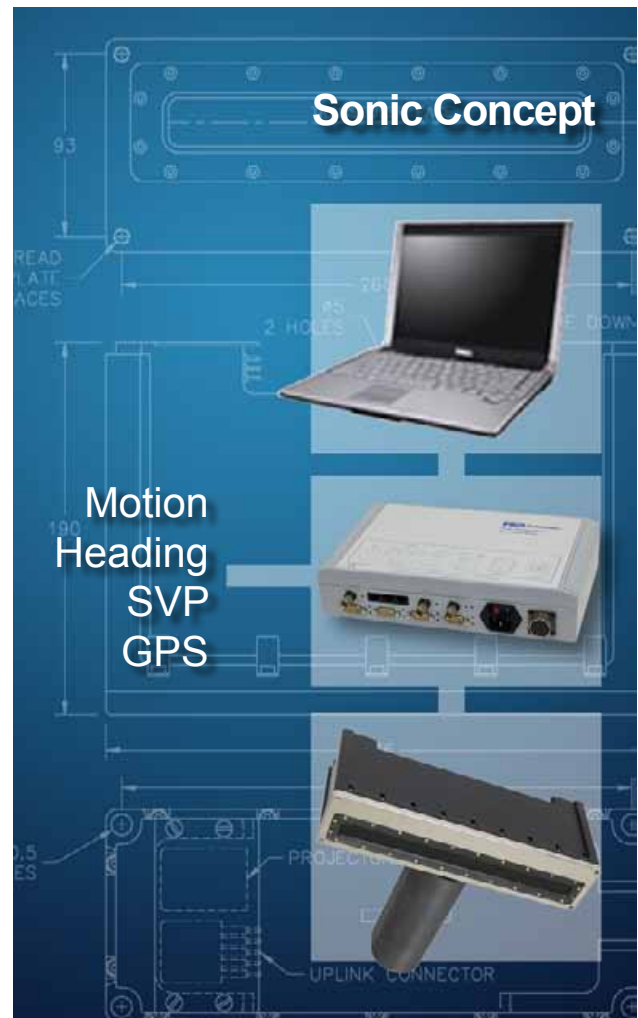

30° - 45° coverage, for increased resolution over bottom features

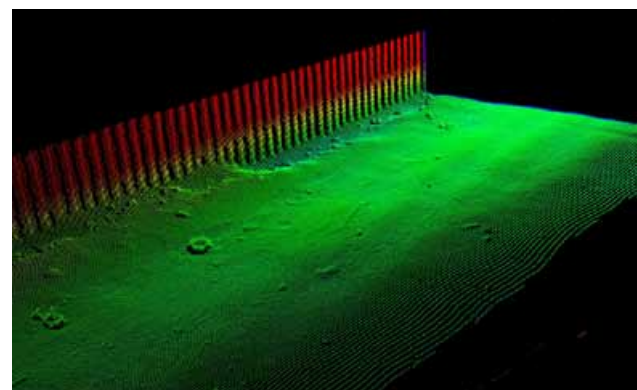

160° coverage, for mapping high up vertical surfaces

# Components

Sonic Wideband Multibeam systems represent new modern design and architecture, unencumbered by legacy designs.

The heavy, bulky and power consuming topside electronic components that characterize old multibeam echo sounder technology have been eliminated.

The sonar consists of three major components: a compact and lightweight projector, a receiver and a small dry side Sonar Interface Module (SIM). The extremely low power draw of 50W (2024), 35W (2022) and 20W (2020) makes it possible to operate the systems on vessel battery power.

Unlike other commercial shallow water multibeam echo sounder systems, all processing is embedded in the sonar receiver, dramatically increasing system efficiency and simplicity in integration.

Third party auxiliary sensors are connected to the sonar Interface module. The sonar data is tagged with GPS time. The compact size, low weight, low power consumption and elimination of separate topside processors make Sonic Wideband Multibeam systems very well suited for small survey vessel or ROV/AUV operations.

For AUV integration, apart from the transmit and receive transducer, the only hardware to be housed on the AUV is an interface board the size of a PC/104, Ethernet ports, and the provision of isolated 48V DC power.

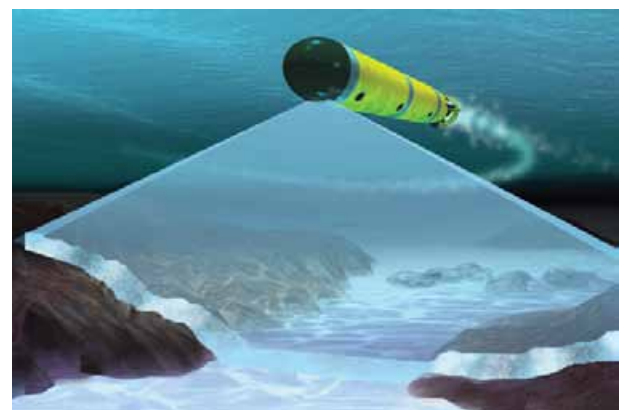

AUV Survey Operation with Sonic Wideband Multibeam system



# Operation

The sonar operation is controlled from a graphical user interface (GUI) on a PC or laptop, which is typically equipped with navigation, data collection and storage application software. The operator sets the sonar parameters in the sonar control window, while depth, imagery and other sensor data are captured and displayed by the application software. Commands are transmitted through an Ethernet interface to the Sonar Interface Module (SIM). The SIM supplies power to the sonar heads, synchronizes, time tags sensor data, and relays data to the application workstation and commands to the sonar head.

The receiver head decodes the sonar commands, triggers the transmit pulse, receives, amplifies, beamforms, bottom detects, packages and transmits the data through the SIM via Ethernet to the control PC.

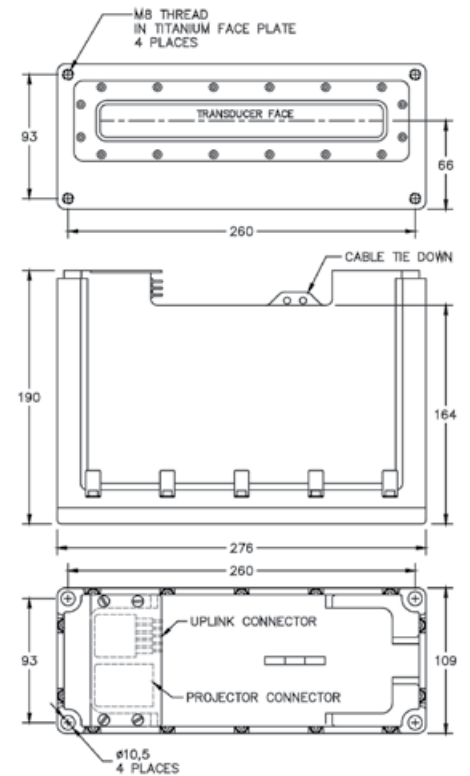

Sonic 2022 Receiver

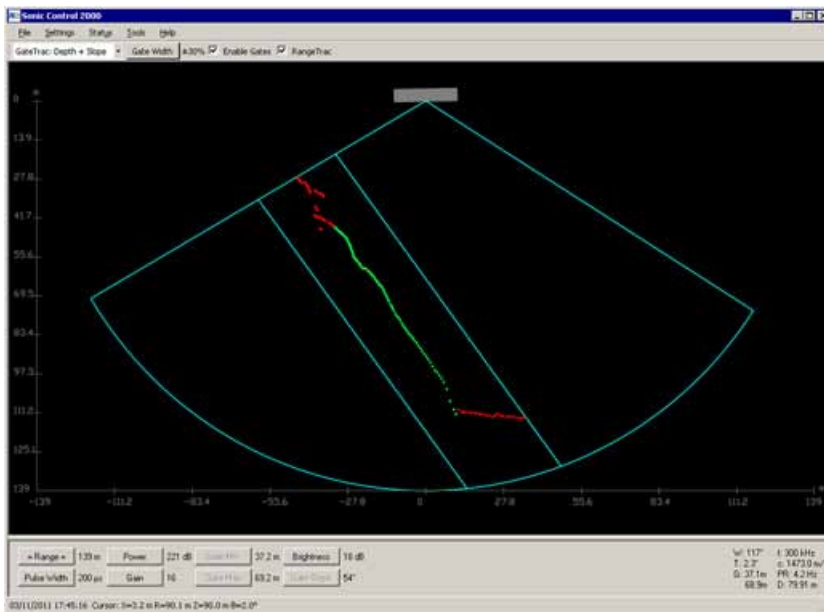

Graphical User Interface (GUI)

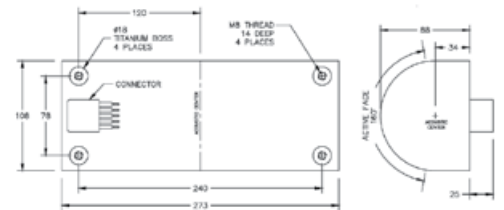

Sonic 2022/2024 Projector

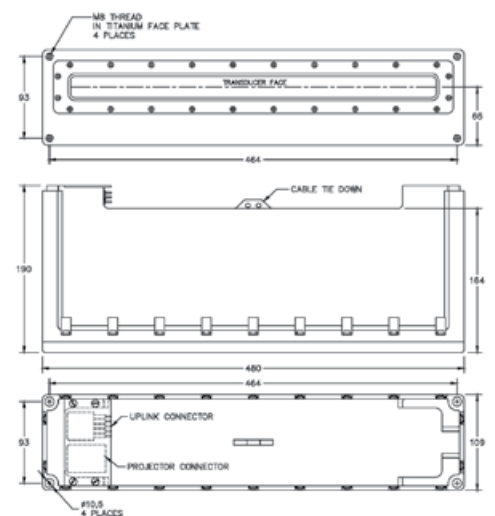

Sonic 2024 Receiver



## Technical Specifications

Feature	Sonic 2024	Sonic 2022	Sonic 2020
Frequency	200 to 400kHz Over 20 frequency selections User selectable in real-time	200 to 400kHz Over 20 frequency selections User selectable in real-time	200 to 400kHz Over 20 frequency selections User selectable in real-time
Bandwidth	60 kHz, all frequency selections	60 kHz, all frequency selections	60 kHz, all frequency selections
Beamwidth	0.3° x 0.6° at 700kHz (optional) 0.5°x1° at 400kHz 1°x 2° at 200kHz	0.6° x 0.6° at 700kHz (optional) 1°x 1° at 400kHz 2°x 2° at 200kHz	2° x 2° at 400kHz 4° x 4° at 200kHz
Swath Sector	10° to 160° All frequency selections User selectable in real-time	10° to 160° All frequency selections User selectable in real-time	10° to 130° All frequency selections User selectable in real-time
Sounding Depth*	400m+	400m+	75m+
Ping Rate	60 Hz	60 Hz	60 Hz
Range Resolution	1.25cm	1.25cm	1.25cm
Pulse Length	15µsec–1000µsec	15µsec–1000µsec	15µsec–1000µsec
Number of Beams	256	256	256
Near-field Focusing	Yes, all beams, over entire swath	Yes, all beams, over entire swath	Yes, all beams, over entire swath
Equiangular or Equidistant beams	Yes	Yes	Yes
Roll Stabilization	Yes	Yes	Yes
Rotate Sector	Yes	Yes	Yes
Automated Operation	Yes	Yes	Yes
Depth Rating	100m, 3000m optional	100m, 3000m optional	500m, 3000m optional
Operating Temp.	-10°C to 50°C	-10°C to 50°C	-10°C to 50°C
Storage Temp.	-20°C to 55°C	-20°C to 55°C	-20°C to 55°C
Mains	90-260 VAC, 45-65Hz	90-260 VAC, 45-65Hz	90-260 VAC, 45-65Hz
Power Consumption	50W	35W	20W
Uplink/Downlink	10/100/1000Base-T Ethernet	10/100/1000Base-T Ethernet	10/100/1000Base-T Ethernet
Deck Cable Length	15m, optional 25m, 50m	15m, optional 25m, 50m	15m, optional 25m, 50m
Receiver Dim (LWD)	480 x 109 x 190mm	276 x 109 x 190mm	155 x 140 x 150mm
Receiver Mass	12 kg	7 kg	4 kg
Projector Dim (LWD)	273 x 108 x 86mm	273 x 108 x 86mm	N/A
Projector Mass	3.3 kg	3.3	N/A
SIM (LWD)	280 x 170 x 60mm	280 x 170 x 60mm	280 x 170 x 60mm
SIM Mass	2.4 kg	2.4 kg	2.4 kg

\*Depending on environmental conditions

## Sonar Options

- Snippets & TruePix™ Backscatter Imagery
- Raw Water Column Data
- Switchable Forward Looking Sonar
- Ultra High Resolution
- Sediment Profiler
- 3000m Immersion Depth Rating
- Integrated Inertial Navigation System (INS)
- Mounting Hardware & Assemblies
- Antifouling Coating Protection

## Corporate Office

**R2Sonic, LLC**

5307 Industrial Oaks Blvd.

Suite 120

Austin, TX 78735

Voice: +1-512-891-0000

E-mail: r2sales@r2sonic.com